

SECTION A-A

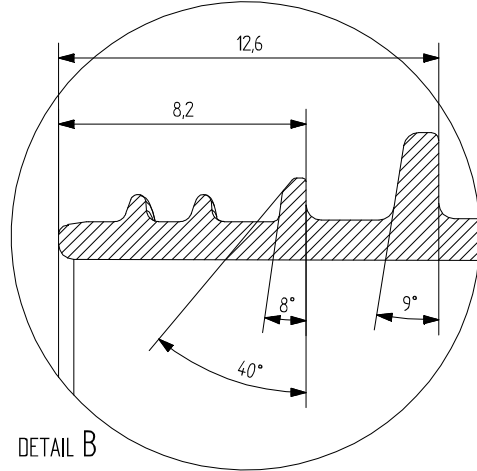

DETAIL B
SCALE 4:1

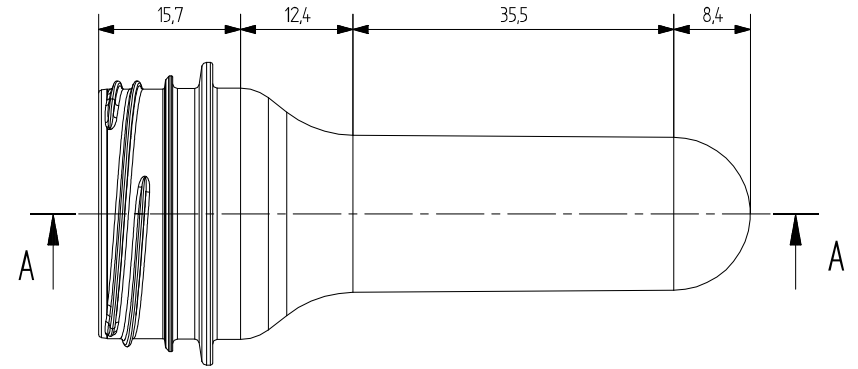

TEKNOPET	TÜM HAKLARI SAKLIDIR. İZİNSİZ KOPYALANMASI VEYA KULLANILMASI DURUMUNDA YASAL İŞLEM UYGULANIR.		ÖLÇEK 1:1
PARÇA KODU	1114		
PARÇA ADI	29/25mm 10.5g Preform Modeli		
MALZEME	PET	KONTROL EDEN	ONAYLAYAN
ÇİZEN	D.A.	B.K.	B.K.